

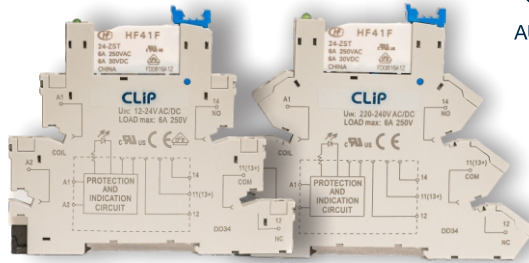

ESCANEE COM A CAMERA



INTERFACE CLIR-SLIM (MOLA E PARAFUSO)

REV.0

DESCRITIVO

As Interfaces CLIR-SLIM foram desenvolvidas para atender painéis em que seja necessário obter espaço para adicionar todos os componentes e proteger equipamentos mais valiosos como **CLP**. Projetada com material anti-chama. Possui acessórios que facilitam sua instalação e identificação como por exemplo: **jumper** para conectar diversas interfaces, **identificador** e **separador**.

INTERFACE CLIR-SLIM (MOLA)

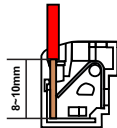
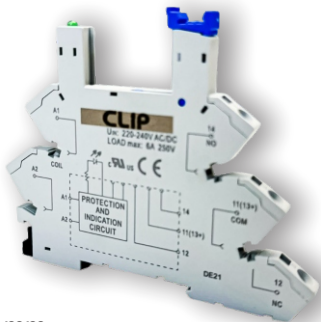

CÓDIGO	ALIMENTAÇÃO	TENSÃO RELÉ	CORRENTE CONTATO RELÉ	TENSÃO CONTATO RELÉ
05040300004	12VCA/VCC	12VCC	6A	250VCA
05040300005	24VCA/VCC	24VCC	6A	250VCA
05040300006	220VCA/VCC	60VCC	6A	250VCA

2,51mm

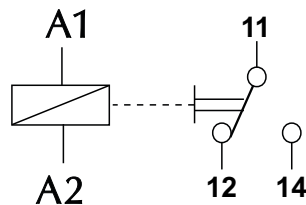
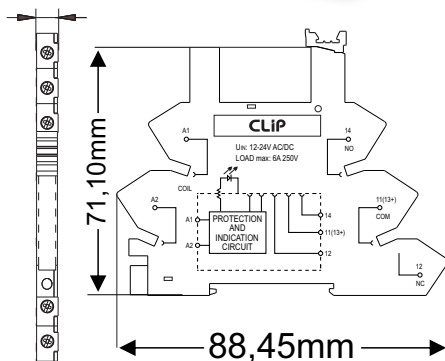

- A1/A2- Alimentação
- 14 - Normalmente Aberto
- 11 - Comum
- 12 - Normalmente Fechado

INFORMAÇÕES DE USO (INTERFACE MOLA)

PARA INSERIR O CONDUTOR:

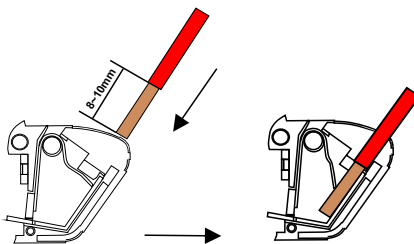

PARA REMOVER O CONDUTOR:

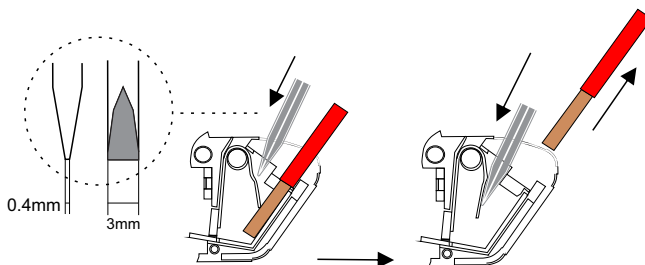

INTERFACE CLIR-SLIM (PARAFUSO)

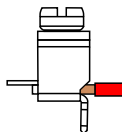
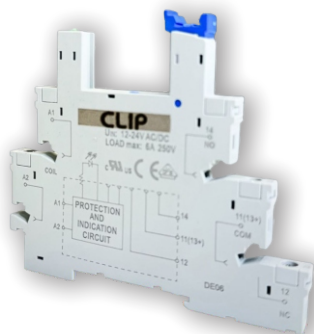

CÓDIGO	ALIMENTAÇÃO	TENSÃO RELÉ	CORRENTE CONTATO RELÉ	TENSÃO CONTATO RELÉ
05040300001	12VCA/VCC	12VCC	6A	250VCA
05040300002	24VCA/VCC	24VCC	6A	250VCA
05040300003	220VCA/VCC	60VCC	6A	250VCA

2,51mm

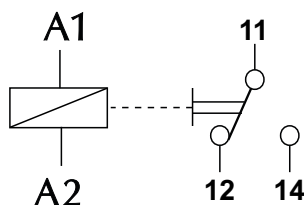
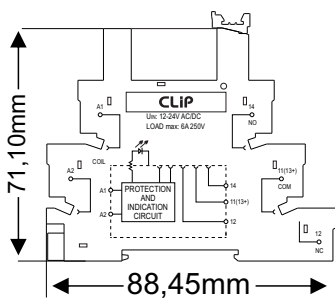

A1/A2- Alimentação
14 - Normalmente Aberto
11 - Comum
12 - Normalmente Fechado

INFORMAÇÕES DE USO (INTERFACE PARAFUSO)

Use as especificações de chave recomendadas para instalação.

Diâmetro do eixo \varnothing -3,5 mm.

Torque de aperto recomendado: 0,5N·m.

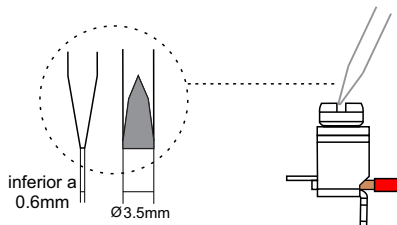

INFORMAÇÕES DO RELÉ

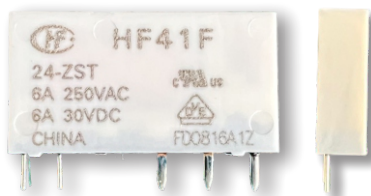

CÓDIGO	TENSÃO NOMINAL	CORRENTE	TENSÃO MÁX.
05040300007	12VCC	6A	250VCA
05040300008	24VCC	6A	250VCA
05040300009	60VCC	6A	250VCA

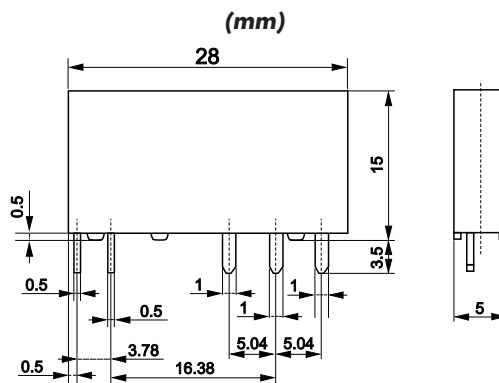
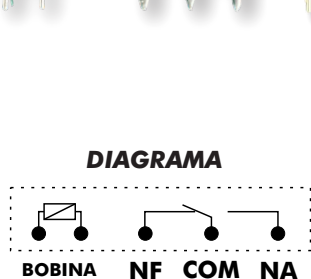

**PARA INSERIR
O RELÉ:**

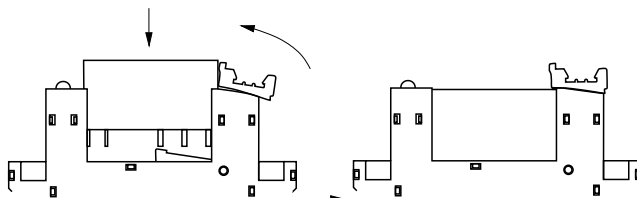

**PARA REMOVER
O RELÉ:**

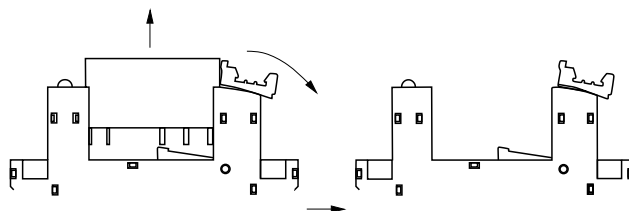

ACESSÓRIO

CÓDIGO	DESCRIÇÃO
05040300010	MARCADOR UNT PARA INTERFACE SLIM
05040300011	MARCADOR MULT PARA INTERFACE SLIM

MARCADOR

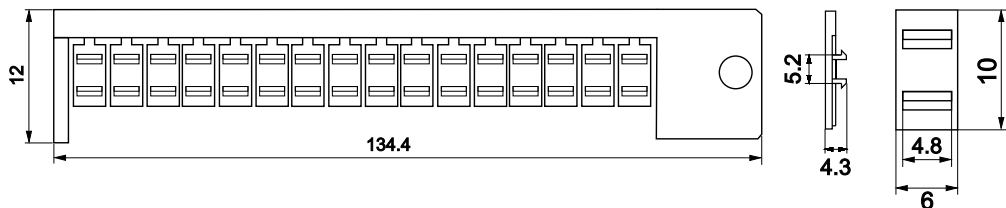

ACESSÓRIO

CÓDIGO	DESCRIÇÃO
05040300012	JUMPER AZUL 20 VIAS P/ INTERFACE SLIM
05040300013	JUMPER VERMELHO 20 VIAS P/ INTERFACE SLIM
05040300014	JUMPER PRETO 20 VIAS P/ INTERFACE SLIM

JUMPER

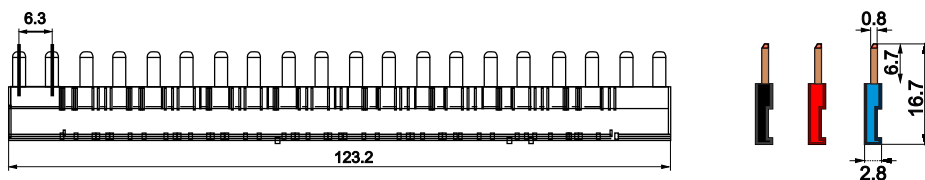

ACESSÓRIO

CÓDIGO	DESCRIÇÃO
05040300015	SEPARADOR P/ INTERFACE SLIM

SEPARADOR

